

## Experimental investigation of cutting forces in 5-axis milling of aerospace alloys

Govind Bhardwaj<sup>a</sup>, Harshil Shah<sup>b</sup>, Ganesh Munge<sup>b</sup>, Suhas Joshi<sup>a</sup>, Asim Tewari<sup>a,b</sup>

<sup>a</sup>Department of Mechanical Engineering, IIT Bombay, Mumbai

<sup>b</sup>National Center for Aerospace Innovation and Research, IIT Bombay, Mumbai

### Abstract

Five-axis milling is a widely used machining process in aerospace manufacturing. Ball end mill cutters are extensively used cutting tool due to their ability to machine complex 3-D sculptured surfaces such as blisks and blades. This paper presents effect of lead and tilt angles on forces, torque and power consumption. Experiments were performed on a Ti-6Al-4V alloy of grade 5 using ball end mill cutter. Plate type Kistler dynamometer was used to record the voltage values. Process parameters like feed, rpm, depth of cut were kept constant during all run but different combinations of lead and tilt were taken. Effect on position of tool-workpiece engagement zone by providing orientation to the tool was also studied.

Keywords: Five-axis milling, lead angle, tilt angle, Ball end mill, Cutting Forces.

### 1. INTRODUCTION

We see technology driven changes in the manufacturing processes everyday across the globe. As technology has been continuously evolving over the last few decades, the demand and importance of lowering the tolerance limit in various industries has been increasing. Industries like aerospace, automotive and die mold machining, are demanding a very high quality of the component which essentially leads to a demand for extremely tight tolerance limit in the manufacturing processes [1]. Manufacturing of turbine propeller and aircraft structural components are made up of high strength alloys containing nickel, aluminium and titanium alloys [2]. These alloys exhibit magnificent mechanical properties but conventional 3-axis milling process does not meet the required tolerance limit. This happens because the tool undergoes deflection due to high forces while cutting. Tool wear over time reduces the tool life significantly, and it essentially governs the duration for which the given tool can be used without compromising the quality (or surface roughness) and accuracy (or deviation from desired surface profile) of the machined part. Apart from tool deflection and tool wear, tool accessibility is also an important concern in free foam surfaces manufacturing. All of these shortcomings can be solved by taking the conventional milling process to the next level, by introducing two more degrees of freedom the lead and tilt angles. Lead and tilt angles determine the orientation of the cutting tool. Cutting forces experienced by the tool can be significantly reduced by the selection of appropriate lead and tilt angles under certain machining conditions. It also gives us more accessibility to cut complex shapes. Machining a difficult-to-cut material like titanium alloys involves high machining cost and low productivity. This is due to the fact that such materials have low thermal conductivity and excessive heat is generated in the cutting zone as less heat dissipation occurs. High material hardness and strength along with the high temperature in the cutting zone results in excessive tool wear and thus lower tool life. Further, as tool wears, it results in poor surface quality. Usually, for aerospace components bulk of the material is machined with the very high buy-to-fly ratio. This fact along with the challenges of machining such materials results in high

machining cost [3]. Ti-6Al-4V is the most widely used titanium alloy because of its excellent mechanical properties. These

alloys have a two-phase structure with  $\alpha$  and  $\beta$  phases making them the most versatile titanium alloys, accounting for majority of titanium usage.

Milling is the most extensively used manufacturing process in the aerospace industry. This is primarily due to the fact that milling can produce complex non-symmetric parts often required in aerospace. Since a large majority of the material is machined (high buy-to-fly ratio) it becomes a major cost driver in the aerospace industry. This cost is further compounded due to large cutting tool cost because of use of high strength materials in aerospace [4]. Hence it is required to optimize the milling process to minimize cutting time and tooling cost without compromising on the geometric tolerances and surface finish. This optimization can be achieved by exploring the total process envelop for milling. In 5-axis milling the process has two additional degrees of freedom in terms of lead and tilt angles. Lead and tilt angles determine the orientation of the cutting tool with respect to the work piece and feed. Cutting forces experienced by the tool can be significantly altered by the changing lead and tilt angles. Hence, it is important to study the effect of lead and tilt angles on cutting forces which in turn will effect tool wear and material removal rate. Thus, the main aim objective of this work was to study how forces get affected with variations in lead and tilt angles for Ti-6Al-4V alloy.

Tool position and orientation in 5-axis milling are defined by using three coordinate system i.e. Machine co-ordinate system (MCS), Tool co-ordinate system (TCS) and process co-ordinate system (FCN). Machine co-ordinate system is the X, Y, Z axes of a machine having previously defined origin and orientation. TCS system comprises of transversal x and y-axes and tool axis as the z-axis. FCN system consists of feed, cross-feed (perpendicular to feed) and normal to the work-piece surface. FCN is the transformation of TCS having lead and tilt angles. The following sections include Experimental work, Observations, Results, and discussions of this study.

## 2. EXPERIMENTAL WORK

### 2.1 Design of experiments

#### 2.1.1 Cutting Tool

1B230-1000-XA 1630 Coro Mill® Plura solid carbide ball nose end mill cutting tool was used for this study. It is a two fluted cutter with a shank diameter of 10mm. It has a helix angle of  $30^\circ$  and rake angle of  $10.5^\circ$ . Its shank length is 53mm, and the usable cutting flute length is 19mm.

#### 2.1.2 Work Material

The material used to perform experiments was Ti-6Al-4V of grade 5. Work specimen dimensions were 80mm x 80mm x 10mm.

#### 2.1.3 Process Parameters

Experiments were performed at a feed rate ( $f$ ) of 480mm/min, cutting speed ( $N$ ) of 3000rpm and depth of cut ( $d$ ) of 0.5mm [5]. These process parameters were kept constant throughout the experiment, whereas orientation of tool axis w.r.t normal in Feed-Normal (FN) plane and in Cross Feed-Normal (CN) plane known as Lead and Tilt respectively (as shown in figure 1) were changed. To eliminate the effect of tool wear on changes in cutting forces, the tool was changed after every four runs. This ensured that the variations in force measurement and surface roughness were entirely due to change in lead and tilt and not due to tool wear.

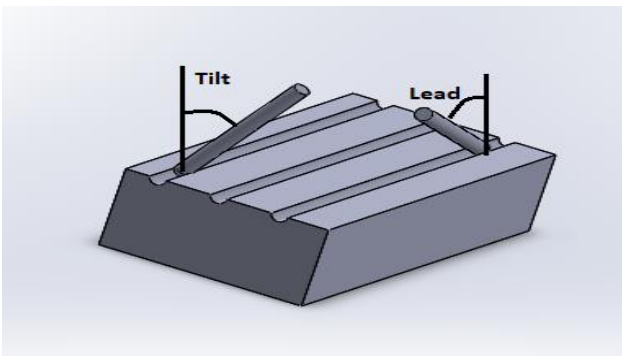

Figure 1. Lead and tilt angles

### 2.2 Experimental Setup

The experiments were done using a five-axis CNC machining center DMG DMC 125FD Duo Block. The forces were measured using Kistler table dynamometer (9124B15111). A fixture was designed to hold a maximum work-piece specimen size of 100mm x 100mm x 12mm. This fixture setup was mounted on the dynamometer and clamped to the worktable of the CNC machine. A schematic of the experimental set-up is shown in Fig. 2. A National instrumentation (NI) signal express software was used to record the output of dynamometer in terms of voltage. Voltage values were recorded after amplifying them for all the three directions. Voltage to force conversion factor was 100 which was automatically decided by the

amplifier on the basis of the range of force selected (this depends on the material and various parameters of machining).

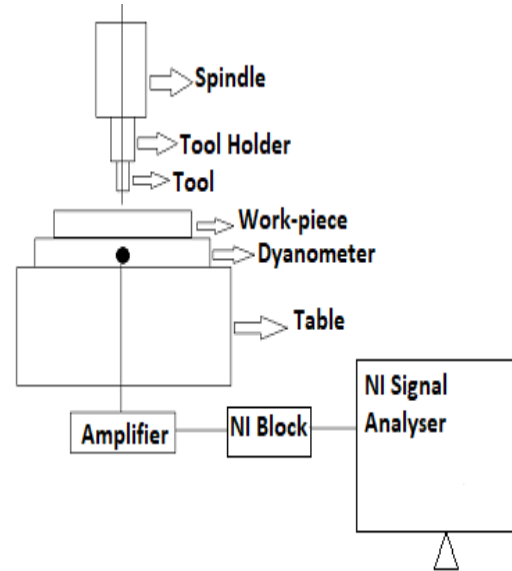

Figure 2. Experimental Set-up

Table 1. Various combinations of Lead and Tilt

Experiment	Tilt Angle	Lead Angle
1	0	0
2	10	0
3	20	0
4	30	0
5	40	0
6	0	-10
7	0	-20
8	0	-30
9	0	-40
10	10	-20
11	20	-10
12	20	-30
13	30	-20
14	30	-40
15	40	-30
16	40	-10

### 3. RESULTS AND DISCUSSION

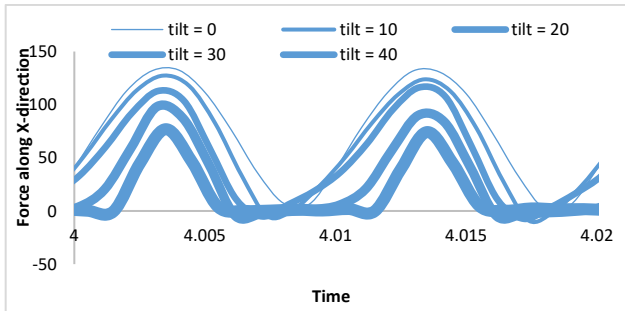

Figure 3. Force variation along Cross-feed direction

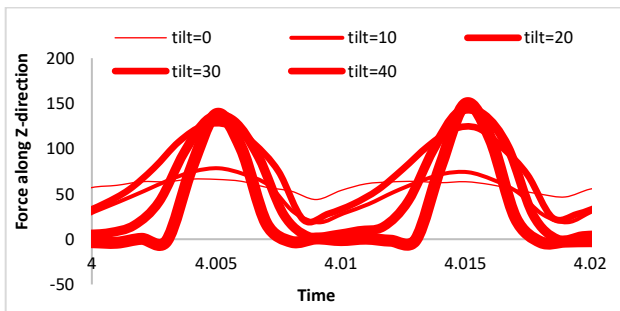

Figure 4. Force variation along Normal direction

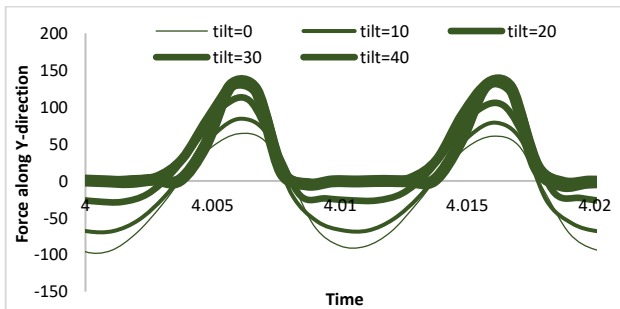

Figure 5. Force variation along Feed direction

Figure 3, 4 & 5 shows the variation of forces (in N) along cross-feed, normal and feed direction respectively. Force along cross-feed direction decreases with increase in tilt angle whereas in normal and feed direction it increases with increase in tilt angle. For very high tilt angles, forces are zero for a greater duration of tool rotation. This duration is around 5 microseconds for tilt angle of  $40^\circ$ . The tool moves  $40\mu\text{m}$  in the feed direction and rotate by  $90^\circ$  in  $5\mu\text{s}$ . Force along normal i.e. Z-direction is almost constant for  $0^\circ$  tilt, but with an increase in tilt angle, forces fluctuate more intensely this can affect tool life.

Figure 6 shows workpiece & tool engagement zone for  $20^\circ$  and  $40^\circ$  tilt angles. It is seen that the engagement zone is on the lower side of tool for  $20^\circ$  tilt angle whereas, this zone is shifted to the upper side of the tool for  $40^\circ$  tilt angle.

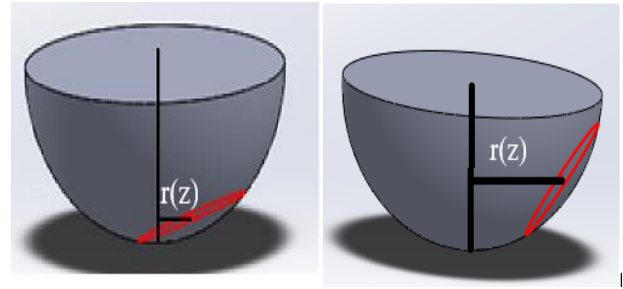

Figure 6. Engagement zone for (a)  $20^\circ$  tilt (b)  $40^\circ$  tilt

Local radius  $r(z)$  in ball end mill is variable along the cutting edge in ball portion of tool and is given by,

$$r(z) = \sqrt{R_0^2 - (R_0 - z)^2}$$

where,

$R_0$  = Radius of cutter

$z$  = Distance of cutting point on edge from bottom of tool

So, an increase in tilt angle will result in an increase in  $z$  due to shifting of the engagement zone towards the upper side of the tool (as seen for  $40^\circ$  tilt angle). This in turn will result in an increase in the local radius. Hence increase in tilt angle would result in an increase in cutting speed, torque (for similar forces) and increase in power consumption (for the same rpm).

Table 2. Variation of Peak force w.r.t tilt

Tilt	Maximum Resultant Force (N)
$0^\circ$	166.06
$10^\circ$	171.57
$20^\circ$	206.82
$30^\circ$	224.10
$40^\circ$	237.90

Table 2 shows the variation of tilt angle and their corresponding peak resultant forces. It should be noted that as the tilt increases the duration of contact of the tool with the workpiece decreases (Fig 4 and 5), thus requiring the tool to cut the same material in a shorter duration. This results in an increase in the peak resultant forces.

Figure 7 shows position when cutting edge is in contact with the workpiece for  $0^\circ$  tilt and non-contact of cutting edge with the workpiece for  $40^\circ$  tilt.

#### 4. CONCLUSION

Lead and tilt angles provided in 5-axis machining significantly affect the Forces, torque and power consumption. Workpiece tool engagement zone is also affected i.e. their shape and position will change as lead and tilt are provided to the tool. Since forces start fluctuating more intensely with tool orientation this can affect tool life.

- [4]. E. Budak and E. Ozturk, "Modeling of 5-axis Milling Processes," 2007, *Machining Science and Technology*, 11:3, 287-311,2007.
- [5]. Harshil Shah, Rahul Reddi, Ganesh Munge, "The Effect of Lead and Tilt angles on the Surface Topography and Cutting Forces of Ti6Al4V Alloy for Ball-End Milling", *International Conference on Precision, Meso, Micro and Nano Engineering (COPEN)-9*.

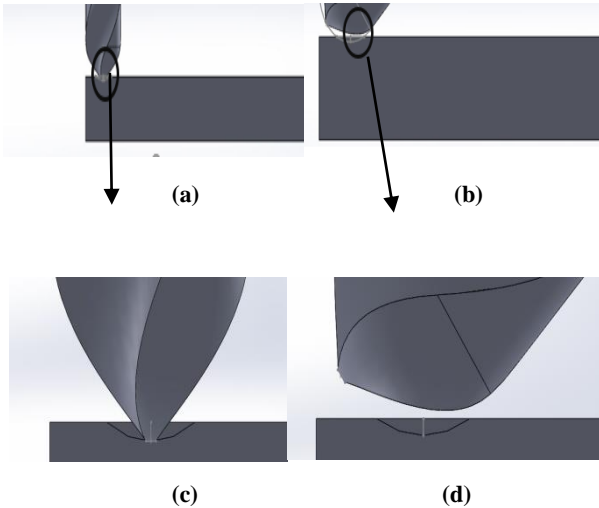

**Figure 7. (a) Cutting edge contact with workpiece for 0° tilt (b) Non-contact of cutting edge for 40° tilt (c) Detailed view of (a) (d) Detailed view of (b)s**

#### ACKNOWLEDGMENT

The authors are thankful to Mr. Rahul Reddi, Mr. Harshil Shah and Mr. Taha Khot for their valuable support in this research. The authors gratefully acknowledge the support provided for this work by the National Centre for Aerospace Innovation and Research, IIT-Bombay, a Dept. of Science and Technology-Government of India, The Boeing Company, and IIT Bombay Collaboration. The authors also acknowledge the support of Sandvik Coromant for providing tools for the experimental work.

#### References

- [1]. E. Ozturk, T. Tunc and E. Budak, "INVESTIGATION OF LEAD AND TILT ANGLES EFFECT IN 5-AXIBALL-END MILLING PROCESSES," *International journal of machine tools and manufacture*, pp. 1053-1062, 2009.
- [2]. E. Budak and E. Ozturk, "Modeling of 5-axis Milling Processes," 2007.
- [3]. A. Shokrani, V. Dhokia, S.T. Newman, environmentally conscious machining of difficult-to-machine materials, with regard to cutting fluids, *International Journal of Machine Tools & Manufacture* 57 (2012) 83-101.